

SMC Cable Attachment Methods

All SMC cable connectors in this catalog have captivated contacts which are soldered to the cable center conductor.

Both crimp and clamp types for flexible cable grip the cable braid with a force greater than the breaking strength of the braid.

Clamp Type For Flexible Cable

These connectors can be assembled without special tooling, and are field replaceable. They provide metal-to-metal clamping of the cable braid.

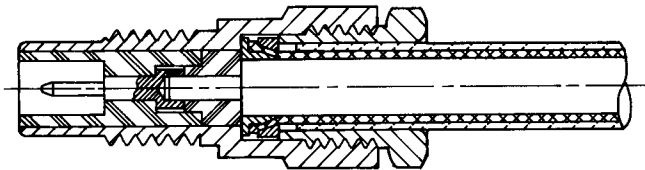

Crimp Type For Flexible Cable

Crimping the cable braid is the most reliable and repeatable method of cable assembly, and provides support for the cable during flexure. AEP crimp type connectors are assembled quickly and easily using readily-available commercial or MIL crimp tools.

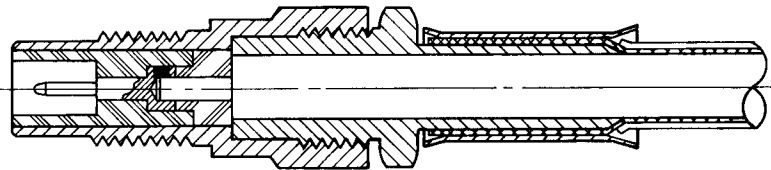

Solder-Clamp For Semi-Rigid Cable

This method allows retrimming of the cable dielectric, if necessary, during assembly. Connectors can be repositioned relative to the cable after assembly by loosening the clamp nut. Solder-clamp connectors are field replaceable without special tools.

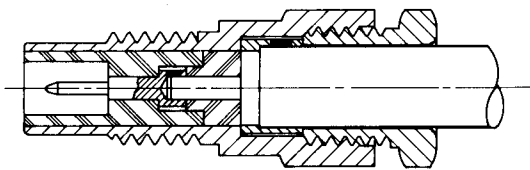

SMC Cable Plugs

Click on part number to go directly to cable assembly instructions

Straight Plugs

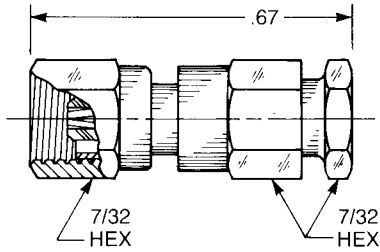

Straight Female Cable Plug

Clamp type for flexible cable:
1002-1551-0XX (Gold plated)
1002-7551-0XX (Nickel plated)

Solder-clamp for semi-rigid cable:
1002-1541-0XX (Gold plated)
1002-7541-0XX (Nickel plated)

QPL version available (M39012/73)

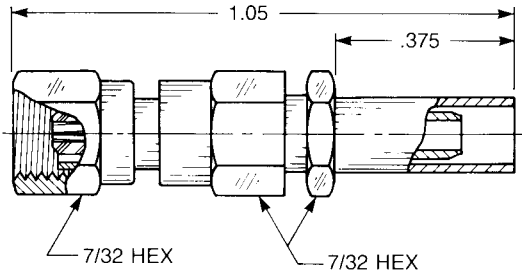

Straight Female Cable Plug

Crimp type for flexible cable:
1002-1571-0XX (Gold plated)
1002-7571-0XX (Nickel plated)

QPL version available (M39012/73)

Right Angle Plugs

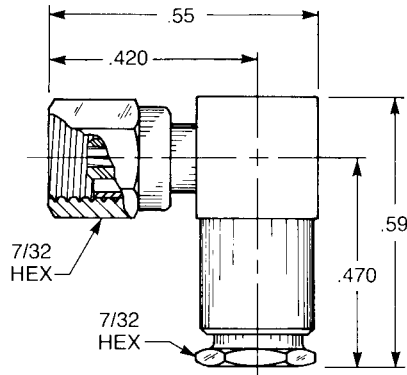

Right Angle Female Cable Plug

Clamp type for flexible cable:
1005-1551-0XX (Gold plated)
1005-7551-0XX (Nickel plated)

Solder-clamp for semi-rigid cable:
1005-1541-0XX (Gold plated)
1005-7541-0XX (Nickel plated)

QPL version available (M39012/75)

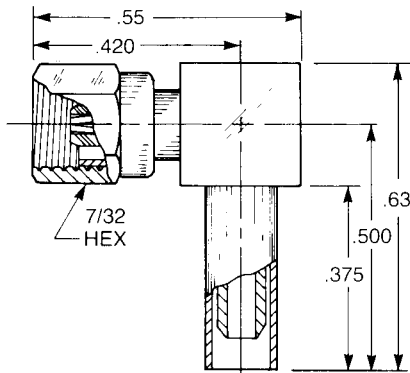

Right Angle Female Cable Plug

Crimp type for flexible cable:
1105-1521-0XX (Gold plated)
1105-7521-0XX (Nickel plated)

QPL version available (M39012/75)

Substitute the appropriate cable group number for "XX" when ordering:

GROUP	CABLE TYPES	GROUP	CABLE TYPES	GROUP	CABLE TYPES
02	RG178, RG196, M17/93, M17/169	05	RG178DS, RG196DS	10	.085" semi-rigid, RG405, M17/133
03	RG174, RG179, RG316, M17/113, M17/119, M17/172, M17/189	09	.141" semi-rigid, RG 402M17/130	19	RG174DS, RG316DS, M17/151, M17/152, Times RD-316



APPLIED ENGINEERING PRODUCTS

(203) 776-2813 • FAX (203) 776-8294

www.aepconnectors.com • aepsales@aepconnectors.com

SMC Cable Jacks

Click on part number to go directly to cable assembly instructions

Straight Jacks

Straight Male Cable Jack

Clamp type for flexible cable: Solder-clamp for semi-rigid cable:
 1001-1551-0XX (Gold plated) 1001-1541-0XX (Gold plated)
 1001-7551-0XX (Nickel plated) 1001-7541-0XX (Nickel plated)

QPL version
 available (M39012/74)

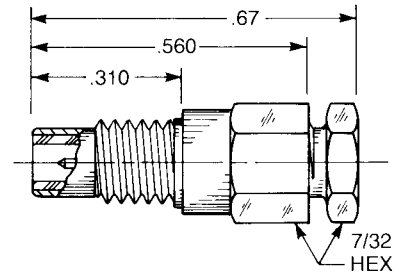

Straight Male Cable Jack

Crimp type for flexible cable:
 1001-1571-0XX (Gold plated)
 1001-7571-0XX (Nickel plated)

QPL version available (M39012/74)

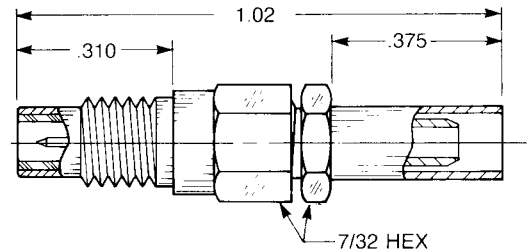

Right Angle Jacks

Right Angle Male Cable Jack

Clamp type for flexible cable:
 1041-1551-0XX (Gold plated)
 1041-7551-0XX (Nickel plated)

Solder-clamp for semi-rigid cable:
 1041-1541-0XX (Gold plated)
 1041-7541-0XX (Nickel plated)

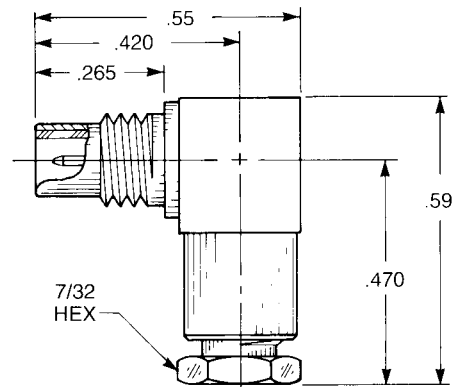

Right Angle Male Cable Jack

Crimp type for flexible cable:
 1141-1521-0XX (Gold plated)
 1141-7521-0XX (Nickel plated)

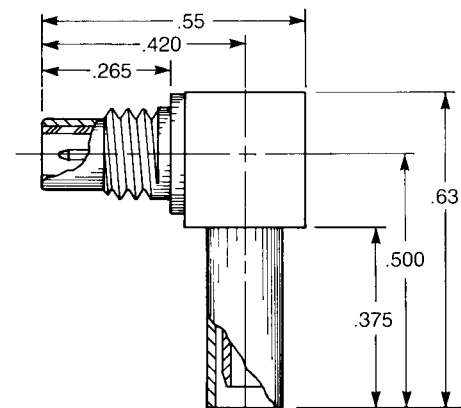

Substitute the appropriate cable group number for "XX" when ordering:

GROUP	CABLE TYPES	GROUP	CABLE TYPES	GROUP	CABLE TYPES
02	RG178, RG196, M17/93, M17/169	05	RG178DS, RG196DS	10	.085" semi-rigid, RG405, M17/133
03	RG174, RG179, RG316, M17/113, M17/119, M17/172, M17/189	09	.141" semi-rigid, RG 402M17/130	19	RG174DS, RG316DS, M17/151, M17/152, Times RD-316



APPLIED ENGINEERING PRODUCTS

(203) 776-2813 • FAX (203) 776-8294

www.aepconnectors.com • aepsales@aepconnectors.com

SMC Bulkhead Mounted Cable Jacks

Click on part number to go directly to cable assembly instructions

Straight Jacks

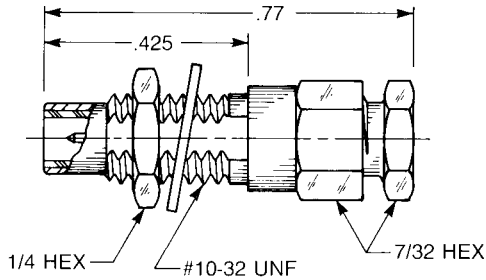

Straight Male Bulkhead Cable Jack

Clamp type for flexible cable: Solder-clamp for semi-rigid cable:
1003-1551-0XX (Gold plated) **1003-1541-0XX** (Gold plated)
1003-7551-0XX (Nickel plated) **1003-7541-0XX** (Nickel plated)

QPL version available (M39012/76)

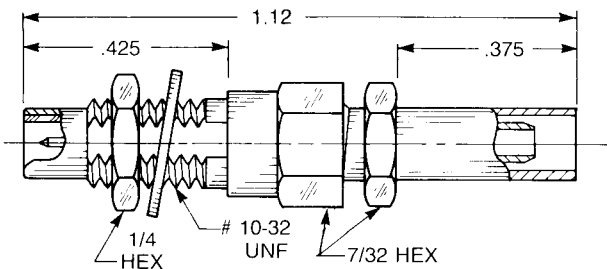

Straight Male Bulkhead Cable Jack

Crimp type for flexible cable:
1003-1571-0XX (Gold plated)
1003-7571-0XX (Nickel plated)

QPL version available (M39012/76)

Right Angle Jacks

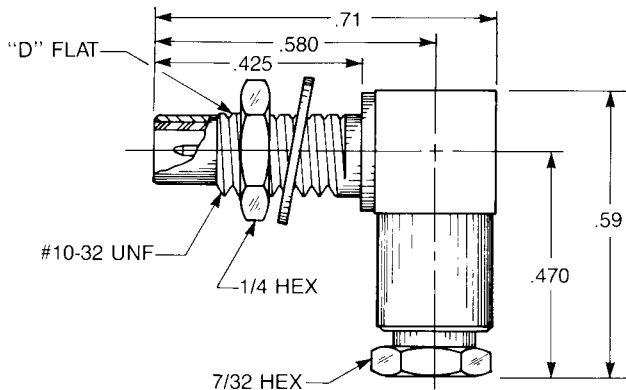

Bulkhead Mounted Right Angle Male Cable Jack

Clamp type for flexible cable:
1006-1551-0XX (Gold plated)
1006-7551-0XX (Nickel plated)

Solder-clamp for semi-rigid cable:
1006-1541-0XX (Gold plated)
1006-7541-0XX (Nickel plated)

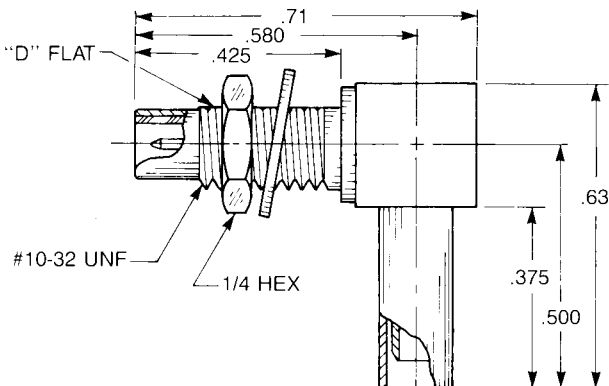

Bulkhead Mounted Right Angle Male Cable Jack

Crimp type for flexible cable:
1106-1521-0XX (Gold plated)
1106-7521-0XX (Nickel plated)

Substitute the appropriate cable group number for "XX" when ordering:

GROUP	CABLE TYPES	GROUP	CABLE TYPES	GROUP	CABLE TYPES
02	RG178, RG196, M17/93, M17/169	05	RG178DS, RG196DS	10	.085" semi-rigid, RG405, M17/133
03	RG174, RG179, RG316, M17/113, M17/119, M17/172, M17/189	09	.141" semi-rigid, RG 402M17/130	19	RG174DS, RG316DS, M17/151, M17/152, Times RD-316



APPLIED ENGINEERING PRODUCTS

(203) 776-2813 • FAX (203) 776-8294

www.aepconnectors.com • aepsales@aepconnectors.com

Cable Assembly Instructions

Clamp type connectors for flexible cable

Straight Connectors—Flexible Cable

Parts list

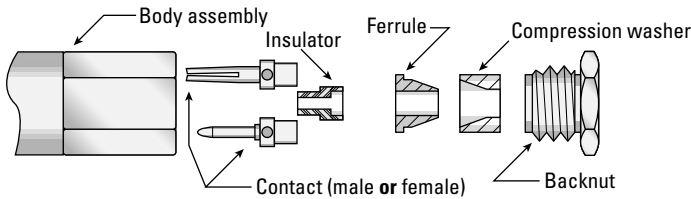

1

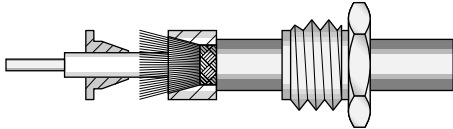

- Trim cable per trim code below; tin end of center conductor.
- Slide backnut onto cable. Slide compression washer onto cable in the orientation shown until it stops against cable jacket.
- Flare cable braid by rotating dielectric and slide ferrule under braid.

2

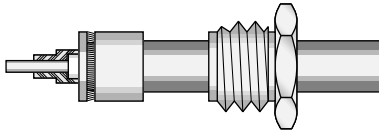

- Press ferrule against compression washer.
- Trim excess braid flush with outer diameter of compression washer and ferrule.
- Assemble insulator over cable center conductor and dielectric.

3

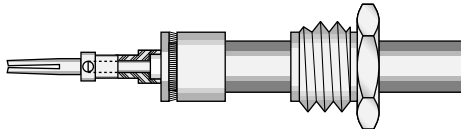

- Assemble contact onto cable center conductor.
- Solder contact to center conductor by heating rear of contact (do not feed additional solder through inspection hole in contact).

4

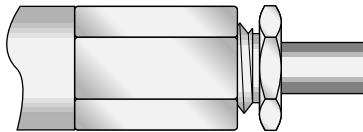

- Insert cable assembly into body assembly. Tighten to 90–100 inch-ounces torque. (Hold cable/hardware assembly stationary and rotate body when tightening.)

Cable Trim Dimensions

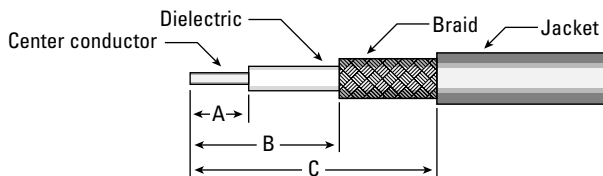

CONNECTOR TYPE	A	B	C
STRAIGHT CONNECTORS	.080	.120	.240
RIGHT ANGLE CONNECTORS	.080	.180	.300

Right Angle Connectors—Flexible Cable

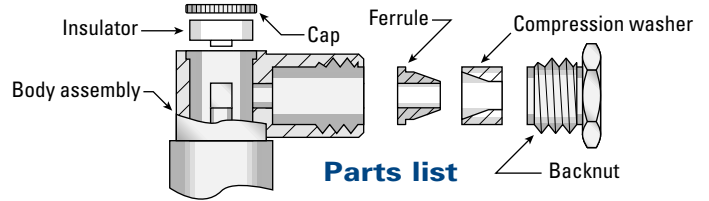

1

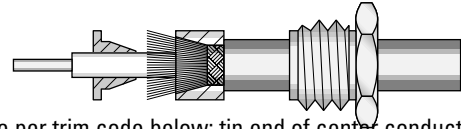

- Trim cable per trim code below; tin end of center conductor.
- Slide backnut onto cable. Slide compression washer onto cable in the orientation shown until it stops against cable jacket.
- Flare cable braid by rotating dielectric and slide ferrule under braid.

2

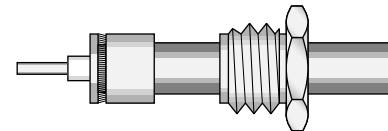

- Press ferrule against compression washer.
- Trim excess braid flush with outer diameter of compression washer and ferrule.
- Assemble insulator over cable center conductor and dielectric.

3

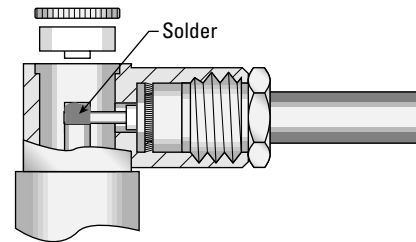

- Insert cable assembly into body assembly. Tighten to 90–100 inch-ounces torque. (Hold cable/hardware assembly stationary and rotate body when tightening.)
- Solder center conductor into notch in rear of contact with .025–.032" diameter chisel-tip soldering iron.
- Solder should cover center conductor, but not extend over top of notch in contact, or exceed contact diameter.

4

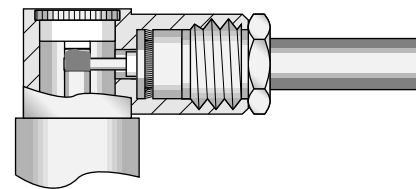

- Place insulator in body cavity, and press cap into place. Properly assembled cap will be slightly below end of body assembly.



Cable Assembly Instructions

Crimp type connectors for flexible cable

Straight Connectors—Flexible Cable

Parts list

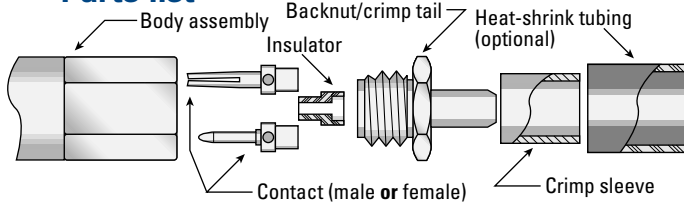

1

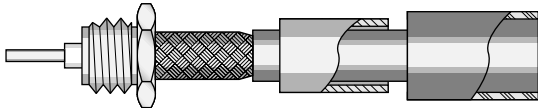

- Trim cable per trim code below; tin end of center conductor.
- Slide heat-shrink tubing and crimp sleeve over cable.
- Flare cable braid by rotating dielectric and slide cable into crimp tail.

2

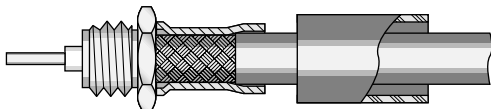

- Position cable so braid touches rear of back nut.
- Slide crimp sleeve forward to touch rear of back nut.
- Crimp braid with appropriate die size from chart below.

3

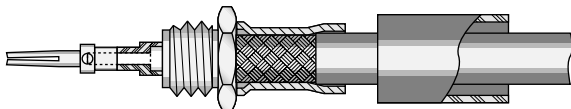

- Assemble insulator and contact onto cable dielectric and center conductor.
- Solder contact to center conductor by heating rear of contact (do not feed additional solder through inspection hole in contact).

4

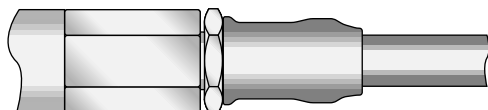

- Insert cable assembly into body assembly. Tighten to 90–100 inch-ounces torque. (Hold cable/hardware assembly stationary and rotate body when tightening.)
- Slide shrink tubing over crimp sleeve and shrink to fit.

Cable Trim Dimensions

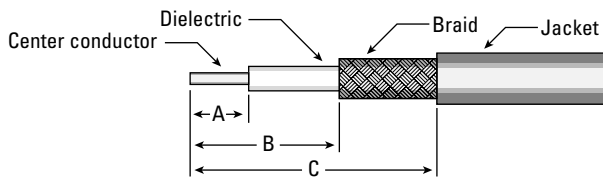

CONNECTOR TYPE	A	B	C
STRAIGHT CONNECTORS	.100	.430	.700
RIGHT ANGLE CONNECTORS	.070	.200	.450

Right Angle Connectors—Flexible Cable

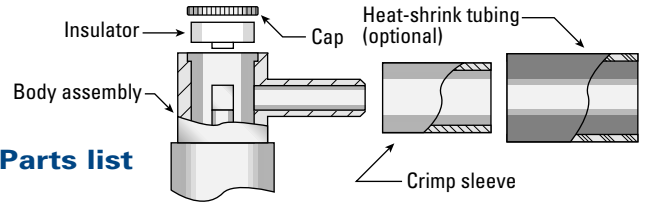

1

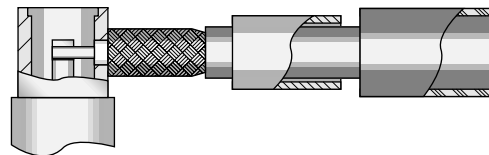

- Trim cable per trim code below; tin end of center conductor.
- Slide heat-shrink tubing and crimp sleeve over cable.
- Flare cable braid by rotating dielectric and slide cable into crimp tail.

2

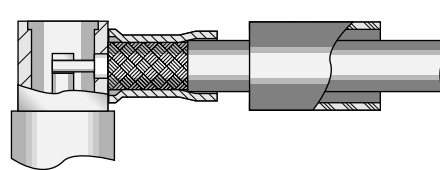

- Position cable so braid touches rear of body assembly.
- Slide crimp sleeve forward to touch rear of body assembly.
- Crimp braid with appropriate die size from chart below.

3

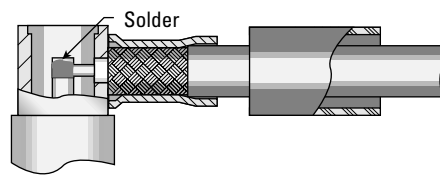

- Solder center conductor into notch in rear of contact with .025–.032" diameter chisel-tip soldering iron.
- Solder should cover center conductor, but not extend over top of notch in contact, or exceed contact diameter.

4

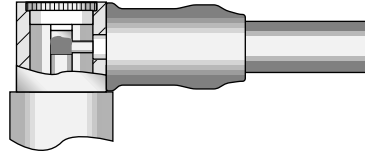

- Place insulator in body cavity, and press cap into place. Properly assembled cap will be slightly below end of body assembly.
- Slide shrink tubing over crimp sleeve and shrink to fit.

Crimp Die Sizes

CABLE GROUP	HEX DIE SIZE
02	.105
03	.128
05	.128
19	.128



APPLIED ENGINEERING PRODUCTS

(203) 776-2813 • FAX (203) 776-8294

www.aepconnectors.com • aepsales@aepconnectors.com

Cable Assembly Instructions

Solder-clamp connectors for semi-rigid cable

Straight Connectors—Semi-Rigid Cable

Parts list

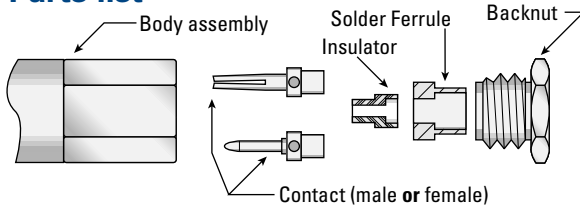

1

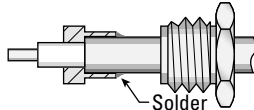

- Trim cable per trim code below; tin end of center conductor.
- Slide backnut over cable. Slide solder ferrule over cable until it stops against cable jacket.
- Solder cable jacket to ferrule.

2

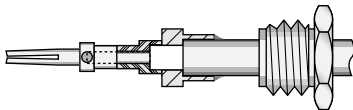

- Assemble insulator and contact onto cable dielectric and center conductor. If insulator is not flush against solder ferrule due to dielectric extrusion, retrim dielectric.
- Solder contact to center conductor by heating rear of contact (do not feed additional solder through inspection hole in contact).

3

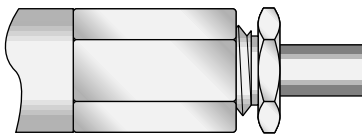

- Insert cable assembly into body assembly. Tighten to 90–100 inch-ounces torque. (Hold cable/hardware assembly stationary and rotate body when tightening.)

Right Angle Connectors—Semi-Rigid Cable

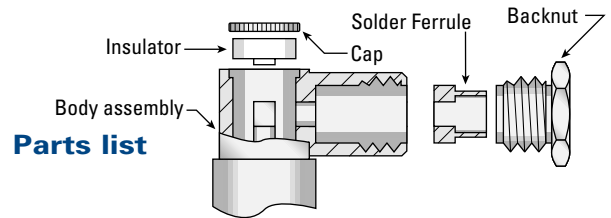

Parts list

1

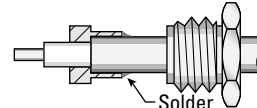

- Trim cable per trim code below; tin end of center conductor.
- Slide backnut over cable. Slide solder ferrule over cable until it stops against cable jacket.
- Solder cable jacket to ferrule.

2

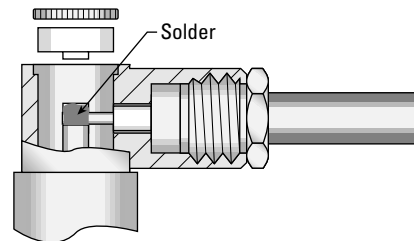

- Insert cable assembly into body assembly. Tighten to 90–100 inch-ounces torque. (Hold cable/hardware assembly stationary and rotate body when tightening.)
- Solder center conductor into notch in rear of contact with .025–.032" diameter chisel-tip soldering iron.
- Solder should cover center conductor, but not extend over top of notch in contact, or exceed contact diameter.

3

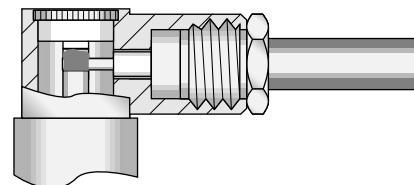

- Place insulator in body cavity, and press cap into place. Properly assembled cap will be slightly below end of body assembly.

Cable Trim Dimensions

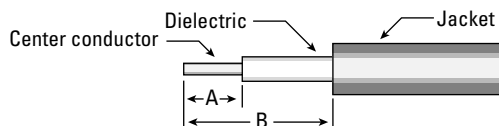

CONNECTOR TYPE	A	B
STRAIGHT CONNECTORS— .085" cable	.090	.170
STRAIGHT CONNECTORS— .141" cable	.105	.130
RIGHT ANGLE CONNECTORS	.110	.150



APPLIED ENGINEERING PRODUCTS

(203) 776-2813 • FAX (203) 776-8294

www.aepconnectors.com • aepsales@aepconnectors.com

Mounting Dimensions

Bulkhead Receptacles

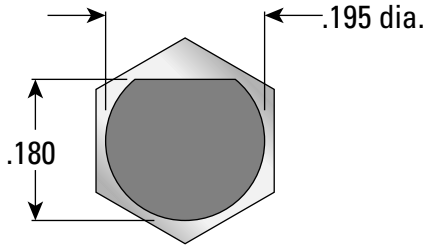

Flat of mounting surface is aligned with body hex as shown.

P.C. Board Receptacles

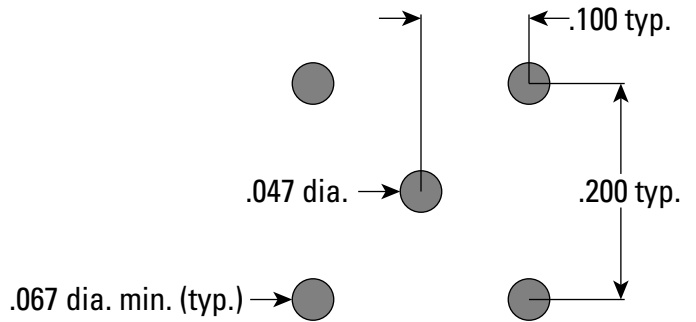

Assembly Tooling

Crimp tool

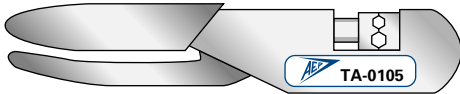

DESCRIPTION	AEP P/N
Crimp tool with .105" and .128" hex dies	TA-0105

Torque Wrench



DESCRIPTION	AEP P/N
Torque wrench with 7/32" jaws for SMC connector backnuts; 95 inch-ounces torque	TA-0436
Torque wrench with 7/32" jaws for SMC coupling nuts; 3 inch-pounds torque	TA-0398

Capping Press

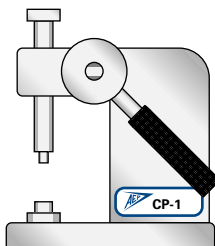

DESCRIPTION	AEP P/N
Capping tool (arbor press) with base for SMC right angle plugs	CP-7
Capping tool (arbor press) with base for SMC right angle jacks	CP-8